

**BRL K536 part E**  
**15-12-2011**

replaces

BRL K536, part E dated 18-06-2008

and amendment sheet dated

04-11-2009

# Evaluation guideline

for the Kiwa (technical approval-with-)product  
certificate for plastics piping systems of PE-X /Al  
intended for transport of hot and cold drinking  
water

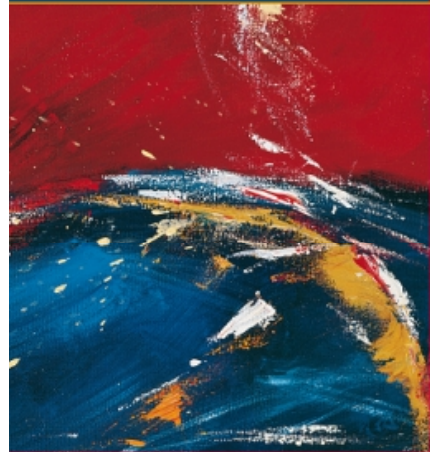

# Preface Kiwa

This evaluation guideline has been prepared by the Kiwa Board of Experts CWK, wherein all the relevant parties in the field of plastics piping systems of PE-X / Al intended for transport of hot and cold drinking water are represented. This Board of Experts also supervises the certification activities and where necessary requires the evaluation guideline to be revised. All references to the Board of Experts in this evaluation guideline pertain to the above mentioned Board of Experts.

This evaluation guideline will be used by Kiwa in conjunction with the Kiwa-Regulations for Product Certification. These regulations details the methods employed by Kiwa for conducting the necessary investigations prior to issuing the product certificate and the method of external control.

## **Kiwa Nederland B.V.**

Sir Winston Churchillaan 273  
Postbus 70  
2280 AB RIJSWIJK  
The Netherlands

Tel. +31 70 414 44 00  
Fax +31 70 414 44 20  
[info@kiwa.nl](mailto:info@kiwa.nl)  
[www.kiwa.nl](http://www.kiwa.nl)

© 2011 Kiwa N.V.

All rights reserved. No part of this publication may be reproduced, stored in a database or retrieval system, or published, in any form or in any way, electronically, mechanically, by print, photo print, microfilm or any other means without prior written permission from the publisher.

The use of this evaluation guideline by third parties, for any purpose whatsoever, is only allowed after a written agreement is made with Kiwa to this end.

## **Validation**

This evaluation guideline has been validated by Kiwa on 15 December 2011.

# Amendment BRL K536 part E

## Plastics piping systems of PE-X /Al intended for transport of hot and cold drinking water

March,13 2018

---

### Validation

Validated by Kiwa Board of Experts CWK on March,12 2018

### Binding declaration

This amendment is declared binding by Kiwa starting March,13 2018.

### Validity of quality declarations

This amendment replaces the amendment sheet of March 10, 2015 and belongs to BRL K536 part E dated December 15, 2011.

The quality declarations issued based on that evaluation guideline keep their validity.

### Right of use

The use of this amendment by third parties, no matter the purpose, is only permitted after this use is settled in a written agreement with Kiwa.

### Description of the change

Due to the transition of the accreditation standard NEN-EN 45011 to the NEN-EN-ISO/IEC 17065 the changes are stated in this amendment which are related to the references to this accreditation standard and in relation to the qualification requirements of the certification staff. Stainless steel fittings are added in table 4.

Change the following paragraphs with the following text:

### 1.3 Acceptance of test reports provided by the supplier

If the supplier submits reports from research bodies or laboratories to show that the requirements of the Evaluation Guideline are met, it will have to be shown that such reports were prepared by a body meeting the applicable accreditation standard, i.e.:

- NEN-EN-ISO/IEC 17020 for inspection bodies;
- NEN-EN ISO/IEC 17021 for certification bodies certifying systems;
- NEN-EN-ISO/IEC 17024 for certification bodies certifying persons.
- NEN-EN-ISO/IEC 17025 for laboratories;
- NEN-EN-ISO/IEC 17065 ór NEN-EN 45011 for certification bodies certifying products;

#### Explanation

NEN-EN-ISO/IEC 17065 is published on September 15, 2012 and will replace NEN-EN 45011. For this the transition period is 3 years.

The body is deemed to meet these criteria if an accreditation certificate can be submitted which has been issued by the Dutch Accreditation Council (RvA) or an accreditation body with which the Dutch Accreditation Council has signed a mutual acceptance agreement.

This accreditation shall relate to the tests required for this Evaluation Guideline. If no accreditation certificate can be submitted, the certification body itself shall verify whether the accreditation standard has been met or (let) carry out the tests concerned itself.

# Amendment BRL K536 part E

## Plastics piping systems of PE-X /Al intended for transport of hot and cold drinking water

March,13 2018

### 4.4.3 Metal Fittings

Change table 4 in:

Table 4 – requirements for metal fittings





Aspect	Eis	Test parameter	Test methode
Material fitting body	<b>Messing:</b> NEN-EN1254-3 NEN-EN 1254-6 NEN-EN 1254-8 <b>RVS:</b> NEN-EN 10088 NEN-EN 10283	IQC <sup>1)</sup>	Information manufacturer
Rubber	BRL K17504	BRL K17504	BRL K17504
Dimensions	NEN-EN1254-3 NEN-EN 1254-6 NEN-EN 1254-8	Minimum thickness	NEN-EN-ISO 228-1 of ISO 7-1
Construction	NEN-EN1254-3 NEN-EN 1254-6 NEN-EN 1254-8	Construction drawings	NEN-EN-ISO 3126
Resistance to inner water pressure (strength fitting body)	No cracks	<b>Brass:</b> NEN-EN1254-3 par. 5.1 NEN-EN 1254-6 Par. 5.1.4 NEN-EN 1254-8 Par.5.1.1 <b>Stainless steel:</b> 25 bar at (23 + 2) °C during 48 hours <sup>2)</sup>	NEN-EN-ISO 1167-1
<b>Brass</b> Resistance to stress corrosion	No cracks	PH 9,5	NEN-ISO 6957
<b>Stainless steel:</b> Resistance to intercrystalline degradation	No cracks	Method A	NEN-EN-ISO 3651-2
<sup>1)</sup> Choice of material is free. The chosen material is listed in the IQC. <sup>2)</sup> The most critical wall thickness/ DN ratio is tested.			

### 4.4.4 Marking

The products are marked with the Kiwa-mark.

#### Marking of the fittings

The minimum required marking on the fittings shall be:

- **KIWA**  or on small products  or  or **KK** \* or **KK** \* (if not possible **KIWA** 
- manufacturer's name, trade name or logo;
- nominal outside diameter of the corresponding pipe in mm;
- production code.

Location of the marks: on every fitting.

The realization of the marks is as follows: clear, durable and indelible.

# Amendment BRL K536 part E

## Plastics piping systems of PE-X /Al intended for transport of hot and cold drinking water

March,13 2018

The smallest packaging unit of the fittings are provided with at least the following information:

- **KIWA**  ;
- manufacturer's name, trade name, system name, logo or certificate number of the accompanying technical approval (system) certificate, in accordance with the marking of the connecting pipe;
- nominal outside diameter and nominal wall thickness of the corresponding pipe in mm;
- material identification in case the fitting body is made of plastics.

Location of the marks: on every package.

The realization of the marks is as follows: clear, durable and indelible.

\*) for small fittings marking with only KK is permitted



\*\*\*) only after approval by Kiwa

### 4.5.5 Marking

The products are marked with the Kiwa-mark.

#### Marking on the pipes

The minimum required marking on the pipes shall be:

- **KIWA**  or  \* + Class 2 / 8 or 10 bar;
- the manufacturer's name, trade name, system name, logo or certificate number of accompanying technical approval (system) certificate;
- material identification: PE-Xa/b/c;
- the build up of the pipe; i.e. PE-(MD)X/Al/PE;
- nominal outside diameter and nominal wall thickness of the pipe in mm;
- production code.

Location of the marks: on every pipe at intervals of not more than 2 m.

The realization of the marks is as follows: clear durable and indelible.

\*) for smaller diameters permitted by Kiwa.

## 8.2 Certification staff

The staff involved in the certification may be sub-divided into:

- Certification assessors / Application reviewers / Reviewers: they are in charge of carrying out the design and documentation reviews, initial certifications, review of applications and assessing of conformation reviews.
- Site assessors: they are in charge of carrying out external inspections at the supplier's works;
- Decision makers: they are in charge of taking decisions in relation with the initial certification tests carried out, continuing the certification in relation with the inspections carried out.

### 8.2.1 Qualification requirements

Distinguished are:

- Qualification requirements for executive staff of a CI that fulfil the requirements of NEN-EN-ISO/IEC 17065 ór NEN-EN 45011 (zie 1.3);

# Amendment BRL K536 part E

## Plastics piping systems of PE-X /AI intended for transport of hot and cold drinking water

March,13 2018

- Qualification requirements for executive staff of a CI that are in addition set up by the Board of Experts for the subject of this evaluation guideline.

The competence of the certification staff involved should be demonstrably recorded

	<b>Certification assessor / Applicatio reviewer / Reviewer</b>	<b>Location assessor</b>	<b>Decision maker</b>
<b>Basic competence</b>			
Knowledge of production processes, skilled in assessing	<ul style="list-style-type: none"> <li>• Bachelor thinking- and working level</li> <li>• 1 year relevant work experience</li> </ul>	<ul style="list-style-type: none"> <li>• Intermediate vocational thinking- and working level</li> <li>• 1 year relevant work experience</li> </ul>	<ul style="list-style-type: none"> <li>• Bachelor thinking- and working level</li> <li>• 4 year relevant work experience with at least 1 year in relation to certification</li> </ul>
Audit skills	• n.a.	<ul style="list-style-type: none"> <li>• Training audit skills</li> <li>• A minimum of 4 assessments whereof 1 assessment indepently under supervision</li> </ul>	n.a.
<b>Technical competence</b>			
Knowledge of the guideline	<ul style="list-style-type: none"> <li>• Detailed knowledge of the guideline and 4 assessments related to the specific guideline or related guidelines.</li> </ul>	<ul style="list-style-type: none"> <li>• Detailed knowledge of the guideline and 4 assessments related to the specific guideline or related guidelines.</li> </ul>	• n.a.
Relevant knowledge of: <ul style="list-style-type: none"> <li>• The technology for the production of the products tob e inspected, the processing and the provision of services;</li> <li>• The application of the products, processes and the provision of services;</li> <li>• Every malfunction which can occur during the use of the product, every error during the process and every defectiveness during the provision of services.</li> </ul>	<ul style="list-style-type: none"> <li>• Relevant tech. thinking and working level comparing to Bachelor</li> <li>• Specific courses and training (knowledge and skills)</li> </ul>	<ul style="list-style-type: none"> <li>• Intermediate vocational thinking- and working level</li> <li>• Specific courses and training (knowledge and skills)</li> </ul>	• n.a.

### 8.2.2 Qualification

Certification staff must be demonstrably qualified by evaluation of education and experience of the above-mentioned requirements.

The authority for qualification rests with the management of the certification institute.

# Table of contents

<b>1</b>	<b>Introduction</b>	<b>3</b>
1.1	General	3
1.2	Field of application	3
1.3	Acceptance of test reports provided by the supplier	3
1.4	Quality declaration	4
<b>2</b>	<b>Terms and definitions</b>	<b>5</b>
2.1	General terms and definitions	5
2.2	Definitions related to the construction	6
2.3	Geometrical terminology and definitions	7
2.4	Material related definitions	8
2.5	Terms and definitions related to service conditions	9
2.6	Symbols	10
2.7	Abbreviations	10
<b>3</b>	<b>Procedure for obtaining the quality declaration</b>	<b>11</b>
3.1	Pre-certification evaluation	11
3.2	Granting the quality declaration	11
<b>4</b>	<b>Product requirements and test methods</b>	<b>12</b>
4.1	General	12
4.2	Requirements to avoid deterioration of the quality of drinking water	12
4.3	Requirements for the joints of the piping system	13
4.4	Product requirements: fittings	15
4.5	Product requirements: pipes	17
<b>5</b>	<b>Corrugated protection pipes</b>	<b>20</b>
5.1	Introduction	20
5.2	Additional test methods	21
5.3	Marking	23
<b>6</b>	<b>Quality system requirements</b>	<b>24</b>
6.1	Manager of the quality system	24
6.2	Internal quality control/quality plan	24
6.3	Procedures and working instructions	24
6.4	Other quality system requirements	24
<b>7</b>	<b>Summary of tests and inspections</b>	<b>25</b>

7.1	Test matrix	25
7.2	Evaluation of the quality system	26
<b>8</b>	<b>Agreements on the performance of certification</b>	<b>27</b>
8.1	General	27
8.2	Certification staff	27
8.3	Report pre-certification tests	28
8.4	Decision for granting of the certificate	28
8.5	Lay-out of the quality declaration	28
8.6	Nature and frequency of external inspections	29
8.7	Interpretation of requirements	29
<b>9</b>	<b>List of mentioned documents</b>	<b>30</b>
9.1	Rules by public law	30
9.2	Standards / normative documents	30
<b>I</b>	<b>Thermal durability outer layer</b>	<b>32</b>
<b>II</b>	<b>Model Technical approval-with-product certificate</b>	<b>34</b>
<b>III</b>	<b>Model Product certificate</b>	<b>36</b>
<b>IV</b>	<b>Model IQC-scheme</b>	<b>38</b>



# 1 Introduction

## 1.1 General

This evaluation guideline includes all relevant requirements which are adhered to by Kiwa as the basis for the issue and maintenance of a (technical approval-with-) product certificate for plastics piping systems of PE-X / Al intended for transport of hot and cold drinking water.

This evaluation guideline replaces BRL K536, part E dated 18-06-2008 and amendment sheet dated 04-11-2009. Certificates issued on the basis of that guideline remain valid.

For the performance of its certification work, Kiwa is bound to the requirements as included in EN 45011 and which are laid down in chapter 8 "Agreements on the performance of certification".

## 1.2 Field of application

The products are intended to be applied in piping systems for hot and cold water distribution at a design pressure (= maximum operating pressure) of 8 or 10 bar (9 or 11 bar absolute or 8 or 10 bar overpressure), under the conditions mentioned in table 1.

Remark:

Each pressure mentioned in this evaluation guideline is defined as overpressure. (So, with "10 bar" a "10 bar overpressure" is meant).

Table 1 - Temperature profile during 50 years

	Temperature [ °C]	Lifetime	Overall service coefficient
T <sub>operation</sub>	70	49 years	1,5
T <sub>max</sub>	80	1 year	1,3
T <sub>malfunction</sub>	95	100 hours	1,0
Remark: the mentioned temperature profile is in accordance with class 2 of ISO 10508.			

## 1.3 Acceptance of test reports provided by the supplier

In case the manufacturer provides reports from test institutions or laboratories showing confirmation that the product meets the requirements of this evaluation guideline, then the instituteshall meet the applicable accreditation norms, being;

- NEN-EN-ISO/IEC 17025 for laboratories;
- NEN-EN 45004 for inspection bodies;
- NEN-EN 45011 for certification bodies certifying products;
- NEN-EN-ISO/IEC 17021 for certification bodies certifying systems;
- NEN-EN-ISO/IEC 17024 for certification bodies certifying persons.

This requirement is considered to being fulfilled when a certificate of accreditation can be shown, either issued by the Board of Accreditation (RvA) or one of the institutions with which the RvA has concluded an agreement of mutual acceptance with.

This accreditation should relate to the tests required for this evaluation guideline.

If no accreditation certificate can be submitted, the certification body shall verify whether the accreditation standard has been met or carry out the tests concerned

#### **1.4 Quality declaration**

The quality declarations to be issued by Kiwa on the basis of this evaluation guideline are specified as Kiwa (technical approval-with-)product certificate.

The models of the quality declarations are included in this guideline as an annex.

## 2 Terms and definitions

### 2.1 General terms and definitions

#### 2.1.1 *Evaluation guideline*

The agreements made within the Board of Experts on the subject of certification.

#### 2.1.2 *Board of Experts*

The Board of Experts "CWK".

#### 2.1.3 *Supplier*

The party responsible for ensuring that the products continuously meet the requirements of this evaluation guideline.

#### 2.1.4 *IQC-scheme*

A description of the quality inspections carried out by the supplier as part of his quality system.

#### 2.1.5 *Product requirements*

Requirements made specific by means of measures or figures, focusing on (identifiable) characteristics of products and containing a limiting value to be achieved, which limiting value can be calculated or measured in an unequivocal manner.

#### 2.1.6 *Pre-certification evaluation*

The evaluation required to ascertain whether all the requirements of the evaluation guideline are met.

#### 2.1.7 *Attestation tests*

Tests in order to ascertain that the product as applied meets the performance requirements of chapter 4.

#### 2.1.8 *Surveillance inspections*

The inspections carried out after the certificate has been granted in order to ascertain whether the certified products continue to meet the requirements of the evaluation guideline. The frequency of inspections is hereby indicated.

#### **Remark**

The test matrix (see chapter 7) contains a summary showing which tests Kiwa will carry out in the pre-certification stage and in the event of surveillance inspections as well as showing the frequency of these inspections and tests.

- 2.1.9 **Technical approval-with-product certificate**  
A document, in which Kiwa declares that a product may, on delivery, be deemed to comply with the product specification as recorded in the certificate.
- 2.1.10 **Tap water (origin NEN 1006)**  
Water intended for drinking, cooking, food preparation or other domestic purposes.
- 2.1.11 **Piping system**  
The total of pipes, protection pipes, fittings, bends, expansion pieces, valves and other piping components.
- 2.1.12 **Flexible piping system**  
A piping system in which possible bends in the pipe can be made without any mechanical means and in which the pipe is not deformed and the flow capacity is not reduced due to the possible bends.
- 2.1.13 **Rigid piping system**  
A piping system in which possible bends in the pipe has to be made by mechanical means.
- 2.1.14 **Mechanical joints**  
A connection between a pipe and a fitting, made by means of pressing a ring or case over the outside diameter of the pipe, with or without extra sealing elements and possibly making use of a supporting ring in the pipe, according NEN EN ISO 6708.
- 2.1.15 **Manifolds**  
An apparatus by which an incoming water flow (adjustable) is divided over several outlets.

## 2.2 Definitions related to the construction

- 2.2.1 **Multilayer pipe**  
Pipes comprised of different stress designed layers.
- 2.2.2 **Multilayer M-pipe**  
Pipes comprised of polymeric layers and one or more metallic layers. The wall thickness of the pipes consist of at least 60% of polymeric materials (e.g. PE-X/Al/PE-X).
- 2.2.3 **Inner layer**  
A layer in contact with the conveyed fluid.
- 2.2.4 **Outer layer**  
A layer exposed to the outer environment.
- 2.2.5 **Embedded layer**  
A layer between the inner and outer layer.

### 2.2.6 *Application layer*

A layer which provides a specific property linked to the conditions of use of the pipe.

### 2.2.7 *Similar construction types: M-pipes*

The construction type is the same for more than one pipe diameter under the following conditions:

- The same process technology for production is used;
- Materials having the same characteristics are used for each stress bearing layer;
- The layers are assembled in the same sequence for different diameters;
- For all diameters the  $SDR_m$  of the aluminium layer is the same (+/- 10%).

Remark: In case for a certain diameter range up to and including 26mm the same aluminium layer thickness is used, the  $SDR_m$  value of the aluminium layer of all smaller diameters of this diameter range can be adapted up to the  $SDR_m$  of the aluminium layer for the biggest diameter of the diameter range. (E.g. a diameter range from 12 mm up to 26 mm with a 0.2 mm aluminium layer).

## 2.3 Geometrical terminology and definitions

### 2.3.1 *Nominal size DN*

Numerical designation of the size of a component, which is a convenient round number, approximately equal to the manufacturing dimensions in millimetres (mm).

### 2.3.2 *Nominal outside diameter ( $d_n$ )*

The specified outside diameter, in millimetres, assigned to a nominal size DN/OD.

### 2.3.3 *Outside diameter (at any point) ( $d_o$ )*

Measured outside diameter through its cross section at any point of a pipe or spigot end of a fitting, rounded up to the nearest 0,1 mm.

### 2.3.4 *Mean outside diameter ( $d_{em}$ )*

Measured length of the outer circumference of a pipe or spigot end of a fitting in any cross section divided by  $\pi$  (3,142), rounded up to the nearest 0,1 mm.

### 2.3.5 *Minimum mean outside diameter ( $d_{em, min}$ )*

Minimum value for the mean outside diameter as specified for a given nominal size.

### 2.3.6 *Inside diameter (at any point) ( $d_i$ )*

The measured inside diameter of the pipe at any point, rounded to the nearest 0,1 mm.

### 2.3.7 *Mean inside diameter ( $d_{im}$ )*

Arithmetical mean value of a number of measurements of the inside diameter in the same cross-section of a pipe, rounded up to the nearest 0,1mm.

### 2.3.8 *Out-of-roundness*

The difference between the measured maximum outside diameter and the measured minimum outside diameter in the same cross-sectional plane of a pipe, or spigot end of a fitting, or the difference between the measured maximum inside

diameter and the measured minimum inside diameter in the same cross-sectional plane of a socket.

**2.3.9 Total wall thickness at any point ( $e$ )**

The measured total wall thickness at any point around the circumference of a component, rounded up to the nearest 0,1 mm.

**2.3.10 Wall thickness of a layer ( $e_l$ )**

The measured wall thickness of a layer at any point around the circumference of a component, rounded up to the nearest 0,1 mm.

**2.3.11 Minimum wall thickness of a layer ( $e_{l,min}$ )**

The minimum value of the measured wall thickness of a layer at any point around the circumference of a component, rounded up to the nearest 0,1 mm.

**2.3.12  $SDR_m$  Metal layer, standard dimension ratio**

The nominal outside diameter ( $d_n$ ) divided by the nominal wall thickness of the metal layer:

$$d_n / e_{n,m}.$$

**2.3.13 Tolerance**

Permitted variation of the specified value of a parameter, expressed as the difference between the permitted maximum and the permitted minimum value of that parameter.

**2.4 Material related definitions**

**2.4.1 Virgin materiaal**

Material in a form such as granules or powder that has not been subjected to use or processing other than that required for its manufacture and to which no reprocessible or recyclable material has been added.

**2.4.2 Own reprocessible material**

Material prepared from rejected unused pipes and fittings, including trimmings from the production of pipes and fittings, that will be reprocessed in a manufacturer's plant after having been previously processed by the same manufacturer by a process such as moulding or extrusion and for which the complete formulation is known.

**2.4.3 Reference product standard**

International standard or draft international standard prepared by the Technical Committee ISO/TC 138/SC 2, applicable for non-multilayer pipes, to which this International Standard can refer for clauses related to the materials, components (e.g. fittings), and fitness for purpose of the system.

**2.4.4 Stress designed polymeric layer**

Polymeric materials designated for layers intended to be stress designed and complying to the requirements of the applicable reference product standard.

## 2.5 Terms and definitions related to service conditions

### 2.5.1 *Lifetime*

The time during which the piping system has to function with a certain operating temperature.

### 2.5.2 *Operating temperature ( $T_{operation}$ )*

The temperature of the water in a piping system during service conditions.

### 2.5.3 *Maximum temperature ( $T_{max}$ )*

The highest temperature of the water in a piping system during service conditions that occurs during a certain period of time (the highest occurring operating temperature during a short time).

### 2.5.4 *Malfunction temperature ( $T_{malfunction}$ )*

The highest temperature of the water in a piping system occurring under abnormal circumstances, for example because of malfunctioning of the system, during a short time (maximum 100 hours per 50 years).

### 2.5.5 *Cold water temperature ( $T_{cold}$ )*

Temperature of the cold water with a maximum of 25 °C. For the calculation of the design pressure a water temperature of 20 °C is used.

### 2.5.6 *Design pressure ( $p_D$ ).*

The allowable pressure in the piping system that, during continuous use, during 50 years may occur for a class 2 material with a temperature profile according table 1.

### 2.5.7 *Temperature profile*

The most frequently appearing operating temperatures that occur during a certain time during 50 years.

### 2.5.8 *Overall service coefficient ( $C$ )*

A coefficient with a value greater than 1, which takes into consideration service conditions as well as properties of the components of a piping system other than those represented in the lower confidence limit, LPL.

### 2.5.9 $P_T$

The pressure in bar, applied to a test piece for a certain temperature and time.

### 2.5.10 $P_{LPL}$

The pressure, that represents the value of the 97,5% lower confidence limit of the predicted pressure for a single value at a temperature T and a time t.

### 2.5.11 $P_{LTHS}$

The pressure, that represents the value of the 50% lower confidence interval of the predicted pressure for a single value at a temperature T and a time t.

### 2.5.12 *LPL*

The lower confidence limit. A statistical unit representing the point above which 97,5 % of all values are found.

## 2.6 Symbols

C	service (design) coefficient
$d_e$	outside diameter (at any point)
$d_{em}$	mean outside diameter
$d_{em,min}$	minimum mean outside diameter
$d_{em,max}$	maximum mean outside diameter
$d_n$	nominal diameter
e	wall thickness at any point
$e_{max}$	maximum wall thickness at any point
$e_{min}$	minimum wall thickness at any point
$e_n$	nominal wall thickness
p	pressure
$p_D$	design pressure
T	temperature
$T_{cold}$	cold water temperature
$T_{operation}$	operating temperature
$T_{malfunction}$	malfunction temperature
$T_{max}$	maximum design temperature
t	time
$p_{LPL}$	pressure at the lower confidence limit

## 2.7 Abbreviations

CPD	Construction Products Directive
CvD	Board of Exerts
CKW	Commissie voor Kwaliteitseisen van Waterleidingartikelen (Committee for Quality requirements of drinking water commodities)
DN	nominal size
DN/OD	nominal size related to the outside diameter
PE-X	cross-linked polyethylene (of high density)
PE-MDX	cross-linked polyethylene (of medium density)
PE-Xa	PE-X cross-linked with peroxide
PE-Xb	PE-X cross-linked with silan
PE-Xc	PE-X cross-linked with electron beam
PE-Xd	PE-X cross-linked with azonitril
MFR	melt flow rate



# 3 Procedure for obtaining the quality declaration

## 3.1 Pre-certification evaluation

The pre-certification evaluation to be performed is based on the (product) requirements as described in this evaluation guideline, including the test methods and contain, depending on the nature of the product to be certified:

- type testing to determine whether the products comply with the product and/or functional requirements;
- Production process assessment;
- Assessment of the quality system and the IQC-scheme;
- Assessment of the presence and functioning of other required procedures.

## 3.2 Granting the quality declaration

After finishing the pre-certification evaluation, the results are presented to the person deciding on granting of the certificate. This person evaluates the results and decides whether the certificate can be granted or additional data and/or tests are necessary.

## 4 Product requirements and test methods

### 4.1 General

In this chapter the requirements imposed on the PE-X/Al piping system intended for the transport of hot and cold drinking water are included, as well as the test methods in order to be able to determine whether the requirements are fulfilled.

### 4.2 Requirements to avoid deterioration of the quality of drinking water

Products and materials, which (may) come into contact with water, drinking water or warm tap water, are not allowed to release substances in such quantities which can jeopardise the health of the consumer or the quality of the drinking water. For that, the products or materials have to meet the toxicological, microbiological and organoleptical requirements which are laid down in the valid "Ministerial Regulation materials and chemicals drinking water- and warm tap water supply" (published in the Government Gazette). This means that the procedure for obtaining a recognised quality declaration, as meant in the valid Regulation, has to be concluded with positive results.

Products and materials with a quality declaration\*<sup>1</sup>, issued by e.g. a foreign certification institute, are allowed to be used in the Netherlands, provided that the Minister has declared this quality declaration equivalent to the quality declaration as meant in the Regulation.

---

<sup>1</sup> \* A quality declaration issued by an independent certification institute in another member state of the European Community than the Netherlands or another state party to the agreement to the European Economic Area, is equivalent to a recognised quality declaration, to the extent that, to the judgment of the Minister of the first mentioned quality declaration, at least equivalent requirements as meant in the Regulation materials and chemicals drinking water- and warm tap water supply, are fulfilled.

### 4.3 Requirements for the joints of the piping system

#### 4.3.1 *General*

The joints in the piping system shall be tested with regard to their proper functioning. In this chapter all joint tests required for the joint system are included. The combination of a (possible) rubber seal, pipe, (possible) supporting insert and clamp construction in the fitting have to be tested with regard to the aspects as mentioned in table 2.

#### 4.3.2 *Tightness and strength of the joints*

After testing in accordance with table 2, the pipe ends shall show no damages. If not otherwise stated, the testing temperature is  $(23 \pm 2)$  °C.

#### 4.3.3 *Manifolds*

Manifolds may form a part of the piping system and must in that case fulfil the requirements of clause 4.4.

#### 4.3.4 *Corrugated protection pipes*

If the aluminium layer of the PE-X/Al pipe is completely closed and welded, corrugated protection pipes are not compulsory.

If the aluminium layer is not completely closed (i.e. perforated), the corrugated protection pipes are compulsory unless the producer declares the PE-X/Al pipe opaque to prevent the possible growth of algae in the pipe.

Corrugated protection pipes can be part of the system and if corrugated protection pipes are used, the requirements and test methods according to chapter 5 have to be complied with.

#### 4.3.5 *Installation instructions*

The supplier shall provide installation instructions. The instructions shall be in the Dutch language and must contain specific information for construction of the joints. Also information must be given with regard to storage, transport, processing temperature etc.

Table 2 - tightness and strength of the pipe joints

Aspect	Requirement	Test parameters	Test method
Temperature cycling test	no leakage	5000 cycles $T_{\max} = (90 \pm 2) \text{ }^{\circ}\text{C}$ $T_{\min} = (20 \pm 2) \text{ }^{\circ}\text{C}$ $t_{\text{cyclus}} = 30 \text{ min } ^1$ . $P_D$ (bar) Preliminary stress = 1,8 MPa <sup>3)</sup> One test piece	EN 12293
Pressure cycling test	no leakage	Three test pieces 10.000 cycles (30 ± 5) cycles/min Test pressure (bar)	EN 12295
		$P_D = 8 \text{ bar}$ $P_D = 10 \text{ bar}$	
		$P_{\max} = 12,0$ $P_{\max} = 15,0$ $P_{\min} = 0,5$ $P_{\min} = 0,5$	
Resistance to tensile force	No separation of pipe and fitting no scratches or breakage within the distance d (= diameter of the pipe) on the pipe and fitting	$t = (60 \pm 1) \text{ min.}$ Three test pieces $F = 1,5 \times \pi / 4 \times D_n^2 \times 10 \text{ (N)}$ $D_n$ in mm	EN 712
Resistance to vacuum	$\Delta P \leq 0,05 \text{ bar}$	$t = (60 \pm 1) \text{ min.}$ Three test pieces $P = -0,8 \text{ bar}$	EN 12294
Resistance to bending ( $\varnothing \geq 32 \text{ mm}$ )	no leakage	$t = (60 \pm 1) \text{ min.}$ Three test pieces	EN 713
		Test pressure ... bar <sup>2)</sup>	
Strength joints	no leakage	$t = 1000 \text{ h.}$ $T = 95^{\circ}\text{C}$ Minimum of 3 connections	ISO 1167-series
		Test pressure ... bar <sup>2)</sup>	
<sup>1)</sup> $t_{\text{cyclus}} = t_{T_{\max}} + t_{T_{\min}} (= 15_0^{+1} + 15_0^{+1} = 30_0^{+2})$ minutes. Total time = 2500 hours) <sup>2)</sup> Information from manufacturer, determined according to EN ISO 21003-5 <sup>3)</sup> Value according to ISO 15875-5 and based on the wall thickness of the PE-X inner layer			

#### 4.4 Product requirements: fittings

##### 4.4.1 *Plastics fittings*

The plastics fittings shall fulfill the requirements of table 3.

Table 3 - requirements for plastics fittings

Aspect	Requirement	Test parameter	Test method
Material	According IQC <sup>1)</sup>	According IQC <sup>1)</sup>	According IQC <sup>1)</sup>
Long-term Strength	≥ design stress ( $\sigma_D$ ) according to the relevant product standard at class 2	Resistance to internal hydraulic pressure <sup>2)</sup> - at 20 °C - between 60 and 80 °C - at 95 °C - at 110 °C	ISO 1167-series with the help of ISO 9080
Dimensions	Specification manufacturer	Dimensions	ISO 3126
Rubber	BRL 17504	BRL 17504	BRL 17504
Degree of cross linking (PE-X fittings)	PE-Xa ≥ 70% PE-Xb ≥ 65% PE-Xc ≥ 60% PE-Xd ≥ 60%	Degree of cross linking	EN 579
Melt flow index (PPR fittings)	≤ 30% difference with respect to granulated material	Mass 2,16 kg Temperature 230 °C Test period 10 min	EN-ISO 1133
Melt flow index (PB fittings)	≤ 0,3 g/10 min difference with respect to granulated material	Mass 5 kg Temperature 190 °C Test period 10 min	EN-ISO 1133
Strength joints	no leakage	t = 1000 h T = 95°C Minimum of 3 test pieces Test pressure .... bar <sup>4)</sup>	ISO 1167-series
Appearance	Smooth without any flaws	Soundness	Visual inspection
Thermal stability <sup>3)</sup>	Test time > 8760 hours	Resistance to internal hydraulic pressure <sup>2)</sup> at 110 °C Applied stress conform the long term strength data	ISO 1167-series
Behaviour at heating	Damages around injection point ≤ 30 % of wall thickness No holes, bubbles or cracks	In consultation with manufacturer	EN-ISO 580
1) IQC: is laid down as part of the certification agreement, after approval of the certification body 2) Test pieces are injection moulded and are cylindrical shaped 3) Results to be processed together with results "long-term strength" 4) Information from manufacturer, determined according to EN ISO 21003-5			

##### 4.4.2 *Metal fittings*

The metal mechanical fittings shall fulfill the requirements of table 4.

Table 4 – requirements for metal fittings

Aspect	Requirement	Test parameter	Test method
Material composition	NEN-EN 1254-3	IQC <sup>1)</sup>	Information manufacturer
Rubber	BRL 17504	BRL 17504	BRL 17504
Dimensions	NEN-EN 1254-3	Minimum thickness	ISO 228-1 or ISO 7-1
Construction	NEN-EN 1254-3	Construction drawings	ISO 3126
Strength fitting body	Resistance to internal hydraulic pressure	NEN-EN 1254-3, clause 5.1	ISO 1167-series
Resistance to Stress corrosion	No cracks	PH 9,5	EN-ISO 6957
<sup>1)</sup> IQC: is laid down as part of the certification agreement , after approval of the certification body			

#### 4.4.3 Certification mark

The following marks and indications must be provided on each product and product packaging in a clear, legible and indelible way:

The fittings shall be provided with at least the following marks:

- ◆ **KK**  (if not possible, then to be provided only on the smallest packaging);
- ◆ manufacturer's name, trade name or logo;
- ◆ nominal outside diameter in mm of the connecting pipe;
- ◆ production code.

The smallest packaging unit of the fittings must be provided with at least the following information:

- ◆ **KIWA**  ;
- ◆ manufacturer's name, trade name, system name, logo or certificate number of the accompanying technical approval(system)certificate, in accordance with the marking of the connecting pipe;
- ◆ nominal outside diameter and nominal wall thickness in mm of the connecting pipe;
- ◆ material identification in case the fitting body is made of plastics.

## 4.5 **Product requirements: pipes**

### 4.5.1 *Introduction*

This chapter embodies the requirements and test methods which are applicable to the pipe.

### 4.5.2 *Classification of the PE-X/Al pipe*

The PE-X/Al pipes shall fulfil the requirements according to the product standard ISO 21003-2.

The calculated values for  $p_D$  shall be higher than or equal to 8 or 10 bar.

### 4.5.3 *Construction of the pipe*

The pipe is composed of 5 layers. From inside to outside the following applies:

A PE-(MD)X inner layer, an adhesive layer, an aluminium layer, an adhesive layer, a plastics (PE-(MD)X or PE) outer layer.

The PE-MDX inner layer shall be classified according the method described in DIN 4724 en DIN 16894.

The PE-X inner layer shall fulfil the requirements according to the product standard ISO 15875-2.

#### 4.5.4 Requirements for pipes

##### 4.5.4.1 Mechanical requirements for the pipe

For the different layers and the complete pipe the requirements according to table 5 apply.

Table 5 – requirements and test methods for PE-X/Al pipes

Aspect	Requirement	Test parameter		Test method
Appearance	Smooth without any flaws	Soundness		Visual inspection
Material	IQC <sup>1)</sup>	IQC <sup>1)</sup>		IQC <sup>1)</sup>
Dimensions of different layers	IQC <sup>1)</sup>	IQC <sup>1)</sup>		IQC <sup>1)</sup>
Resistance to internal pressure <sup>2)</sup> PE-(MD)X/Al pipe	Testing time (hour)	T (°C)	σ (MPa)	ISO 1167
	≥ 22	95	.... <sup>3)</sup>	
	≥ 165	95	.... <sup>3)</sup>	
	≥ 1000	95	.... <sup>3)</sup>	
Thermal stability PE-MDX inner layer	Testing time (hour)	T (°C)	σ (MPa)	ISO 1167
	≥ 8760	110	1,7	
Thermal stability PE-X inner layer	Testing time (hour)	T (°C)	σ (MPa)	ISO 1167
	≥ 8760	110	2,5	
Melting temperature adhesive	≥ 120 °C	DSC method		ISO 11357
Adhesion strength adhesive	F <sub>tensile</sub> ≥ 15 N/cm	Tensile speed 50 ± 5 mm/min		ISO/DIS 17454
Resistance to delamination	F <sub>tensile</sub> ≥ 15 N/cm	Tensile speed 50 ± 5 mm/min After conditioning according to EN 12293		ISO/DIS 17454
Tensile strength aluminium layer	IQC <sup>1)</sup>	Tensile speed 10 mm/min		EN 10002-1 Annex 1 type 1
Elongation at break aluminium layer	IQC <sup>1)</sup>	Tensile speed 10 mm/min		EN 10002-1 Annex 1 type 1
Thermal durability outer layer	No cracks or other damage	1 year at 110°C		Annex I
Influence of heating of complete pipe	≤ 3 %	Change in length 30 min at 120 °C		EN 743, method B
Degree of cross linking of PE-(MD)X material inner layer	PE-Xa ≥ 70% PE-Xb ≥ 65% PE-Xc ≥ 60% PE-Xd ≥ 60%	Degree of cross linking		EN 579
<p>1) IQC: is laid down as part of the certification agreement, after approval of the certification body                  2) For initial evaluation and yearly inspection the 1000 hours test at 95 °C is carried out. The other testing times can be applied during production control.                  3) Information from manufacturer, determined according to EN ISO 21003-2</p>				



#### 4.5.4.2 *Dimensions*

The dimensions of the pipes are determined by the manufacturer depending on the desired construction. The minimum wall thickness of the individual layers must be determined in such a way that the lifetime of 50 years for the desired class and design pressure is not negatively affected (according to ISO 9080).

The minimum wall thickness of the inner layer shall be 0,5 mm.

For the determination of the dimensions, the method according to ISO 3126 must be followed.

#### 4.5.5 *Certification mark*

The following marks and indications must be provided on each product and product packaging in a clear, legible and indelible way:

- ◆ **KIWA**  + Class 2 / design pressure (bar);
- ◆ manufacturer's name, trade name, system name, logo or certificate number of the accompanying technical approval (system)certificate;
- ◆ material identification : PE-(MD)X/Al/material outer layer;
- ◆ nominal outside diameter and nominal wall thickness in mm;
- ◆ production code.

# 5 Corrugated protection pipes

## 5.1 Introduction

The corrugated protection pipes shall fulfill the requirements of table 6.

Table 6 – requirements for corrugated protection pipes

Aspect	Requirement	Test parameter	Test method
Material composition	IQC <sup>1)</sup>	IQC <sup>1)</sup>	IQC <sup>1)</sup>
Appearance	Regular profile. Inner and outer surface is smooth and free from holes, bubbles, contaminations or other flaws.	Soundness	Visual inspection
Mass per length	IQC <sup>1)</sup>	Weight per meter	Par. 5.2.3
Dimensions	IQC <sup>1)</sup>	Dimensions	ISO 3126
Resistance to compression	Compression after 5 minutes not more than 22 %. After neutralization of the load, the outside diameter must be at least 85 % of the initial value	Change in diameter	Par. 5.2.1
Resistance to impact	10 test pieces => no breakage 1 breakage: repeat the test with twice the number of test pieces. Over total of 30 test pieces => not more than 2 breakages	Impact strength	Par. 5.2.2
Resistance to pull-out in radial direction (only with duo pipes <sup>2)</sup> )	Pull-out force > 250 N No damage on the protection pipes	Tensile force	Par. 5.2.3
1) IQC: is laid down as part of the certification agreement, after approval of the certification body. 2) Duo pipes are protection pipes that are connected with a groove connection in the length direction of the pipe. The length of the connection is at least a 50(±1) mm tightly jointed connection per 0,5m pipe.			

## 5.2 Additional test methods

### 5.2.1 Determination of the resistance to compression

#### 5.2.1.1 Apparatus

A test set-up is required, in which the test pieces can be loaded diametrically between two rigid, parallel plates at a temperature of  $(23 \pm 2) ^\circ\text{C}$ , see figure 1.

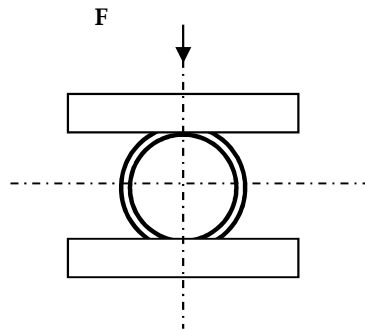

Figure 1 - test set-up for compression

#### 5.2.1.2 Test pieces

For each pipe size to be tested, 3 test pieces are required with a length of  $100 \pm 1$  mm.

#### 5.2.1.3 Procedure

Measure the outer diameter of the test pieces.

Subject the test pieces, equally divided along the length, to a gradually applied load of 200 N. Measure, after 5 minutes of applying the load, the outside diameter of the test piece along the central axis of the load direction. Express the measured compression as a percentage of the initial outside diameter. Neutralize the load after 5 minutes (calculated from the beginning) and let the test pieces rest.

Determine, after 1 minute of neutralizing the load, again the outside diameter of each test piece along the central axis of the former load direction and express the permanent compression as a percentage of the initial outside diameter.

### 5.2.2 Determination of the resistance to impact

#### 5.2.2.1 Apparatus

For the test an impact apparatus is required provided with a striker with a spherical shaped impact bottom with a radius of 12,5 mm and a V-shaped support block at an angle of  $120^\circ$ . Further, a cooler is required in which the test pieces can be conditioned at a temperature of  $(0 \pm 1) ^\circ\text{C}$ .

#### 5.2.2.2 Test pieces

For each pipe size to be tested 10 test pieces are required with a length of 100 mm. The test pieces must be conditioned in water or air at a temperature of  $(0 \pm 1) ^\circ\text{C}$ . When refrigerating in water, the cooling time amounts 30 minutes and when cooling off in air, the cooling time amounts 60 minutes.

### 5.2.2.3 Procedure

Put the test pieces on the V-shaped support block and let the striker fall in the middle of the test pieces. A test piece must be tested within 10 seconds after it is taken out of the cooler. The applicable test conditions are mentioned in table 7.

Table 7 - Test conditions for corrugated protection pipes

Nominal outside diameter of the connecting pipe belonging to the protection pipe for testing	Mass striker in g (-0/+ 5g)	Fall height in mm (-0/+5 mm)
Up to and including 25 mm	250	1000
32 up to and including 50 mm	250	2000

### 5.2.3 Determination of the mass per length

For the determination of the mass per length three corrugated pipes with a length of approximately 1 m are required. The real length must be determined as accurately as possible. The mass of these pipes must be determined, with the help of a balance, with an accuracy of 0,1 gram.

The arithmetic mean of the three values is qualifying.

### 5.2.4 Resistance to pull-out force in radial direction

#### 5.2.4.1 Apparatus

On a tensile tester, two parallel metal pins are installed, with a diameter identical to the internal diameter of the protection pipe. The metal pins on the right side can be moved in parallel direction and the necessary force can be measured. During this test the metal pins shall not bend (see figure 2). During testing the surrounding temperature and the sample temperature shall be.

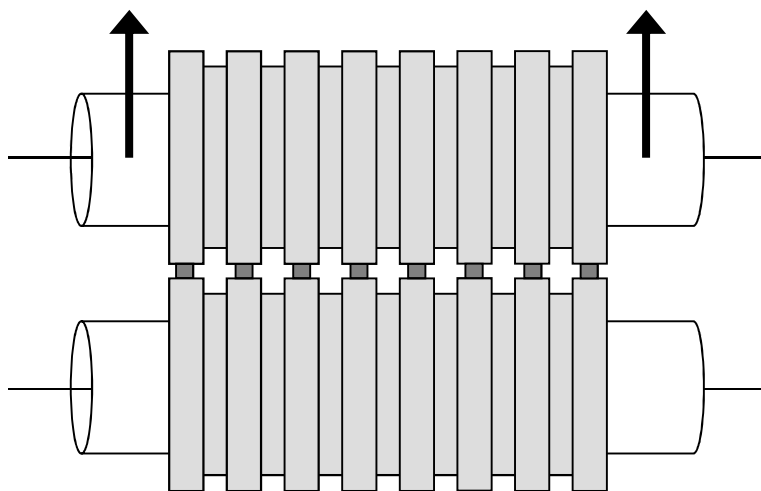

Figure 2 - test model resistance to pull-out force

#### 5.2.4.2 Test pieces

The 5 required test pieces shall have a length of  $(50 \pm 1)$ mm. There shall be a connection between the two protection pipes over the complete length of the test pieces.

#### 5.2.4.3 Procedure

The test pieces are installed over the parallel metal pins. Each pipe half is placed on a different pin, see also figure 2.

When test pieces are installed, the metal pins are moved in radial direction with a speed of 15 mm/min. During this movement the necessary force is recorded. The test is completed when both pipe parts are separated from each other.

The maximum force that is required to complete the test shall be recorded in Newton. All 5 test pieces have to fulfill the requirement.

### 5.3 Marking

The corrugated pipes shall be provided, at intervals of not more than 2,5 m, with the following clearly legible and indelible markings.

- ◆ KIWA (Kiwa® word mark);
- ◆ manufacturer's name, trade name, system name, logo or certificate number of the corrugated protection pipe or certificate number of the accompanying technical approval (system)certificate.

# 6 Quality system requirements

This chapter contains the requirements which have to be met by the supplier's quality system.

## 6.1 Manager of the quality system

Within the supplier's organizational structure an employee must have been appointed who is in charge of managing the supplier's quality system.

## 6.2 Internal quality control/quality plan

The supplier shall have an internal quality control scheme (IQC scheme) which is applied by him.

The following must have been demonstrably recorded in this IQC scheme:

- what aspects are checked by the producer;
- according to what methods such inspections are carried out;
- how often these inspections are carried out;
- in what way the inspection results are recorded and kept.

This IQC scheme should at least be an equivalent derivative of the model IQC scheme included in the addendum.

## 6.3 Procedures and working instructions

The supplier shall be able to submit the following:

- procedures for:
  - dealing with products showing deviations;
  - corrective actions to be taken if non-conformities are found;
  - dealing with complaints about products and/or services delivered;
- the working instructions and inspection forms used.

## 6.4 Other quality system requirements

In case the quality system of the supplier is certified on the basis of ISO 9001, a combination can be made with the IQC-scheme.

# 7 Summary of tests and inspections

This chapter contains a summary of the following tests and inspections to be carried out in the event of certification:

- Pre-certification tests;
- Inspection test as to toxicological requirements and product requirements;
- Inspection of the quality system.

The frequency with which Kiwa will carry out inspection tests is also stated in the summary.

## 7.1 Test matrix

Description of requirement	Clause BRL	Test within the scope of			Change of raw material
		Pre-certification tests	Surveillance by CI after issue of the certificate <sup>1)</sup>		
			Inspection <sup>2)</sup>	Frequency	
<b>System requirements</b>					
Temperature cycling test	4.3.2	X			X
Pressure cycling test		X			
Resistance to tensile force		X			
Resistance to vacuum		X			
Resistance to bending		X			
Strength joints		X	X	1x year	X
<b>Requirements for plastics fittings/dividers</b>					
Material (inclusive toxicological aspects)	4.4.1	X	X	1x year	X
Long-term strength		X	X <sup>3)</sup>	1x year	X
Dimensions		X	X	1x year	X
Rubber		X			X
Degree of cross linking/ MFR		X	X	1x year	X
Strength joints (see system)		X	X	1x year	X
Appearance		X	X	1x year	X
Thermal stability fitting		X			X
Influence of heating		X	X	1x year	X
<b>Requirements for metals fittings/dividers</b>					
Material composition	4.4.2	X	X	1x year	X
Rubber		X			X
Dimensions		X	X	1x year	X
Construction		X			X
Strength body		X			X
Resistance to stress corrosion		X			X
<b>Requirements for the pipe</b>					
Long-term strength	4.5	X	X <sup>3)</sup>		X
Appearance		X	X	1x year	X
Material (inclusive toxicological aspects)		X	X	1x year	X
Dimensions		X	X	1x year	X
Degree of cross linking inner layer		X	X	1x year	X
Melting temperature adhesive		X			X
Adhesion strength adhesive		X			X
Resistance to delamination		X			X
Resistance to internal hydraulic pressure		X	X	1x year	X
Thermal stability inner layer		X			X
Influence of heating		X	X	1x year	X
Thermal durability of the outer layer		X			X

*Continuation of test matrix*

Description of requirement	Clause BRL	Test within the scope of			Change of raw material
		Pre-certification tests	Surveillance by CI after issue of the certificate <sup>1)</sup>		
			Inspection <sup>2)</sup>	Frequency	
<b>Requirements for the corrugated protection pipe</b>					
Material composition	5	X	X <sup>3)</sup>	1x year	X
Appearance		X	X	1x year	X
Mass per length		X	X	1x year	X
Dimensions		X	X	1x year	X
Resistance to compression		X	X	1x year	X
Resistance to impact		X	X	1x year	X
Resistance to pull-out in radial direction (for duo pipes)		X	X	1x year	X

- 1) In case the product or production process changes significantly, the performance requirements must be determined again.
- 2) All product properties that can be determined within the visiting time (maximum 1 day) are determined by the inspector or by the supplier in the presence of the inspector. In case this is not possible, an agreement will be made between the certification body and the supplier about how the inspection will take place.
- 3) This aspect is compared with the for this aspect ascertained acceptance parameters on the basis of the IQC inspection (indirect by means of direct related parameters).

## 7.2 Evaluation of the quality system

During each inspection visit the quality system of the supplier shall be examined and evaluated.



# 8 Agreements on the performance of certification

## 8.1 General

Beside the requirements included in these evaluation guidelines, also the general rules for certification as included in the Kiwa Regulations for Product Certification apply.

These rules are in particular

- The general rules for conducting the pre-certification tests, to be distinguished in:
  - the way suppliers are to be informed about an application is being handled;
  - how the test are conducted;
  - the decision to be taken as a result of the pre certification tests.
- The general directions for conducting inspections and the aspects to be audited;
- The measurements to be taken by Kiwa in case of Non Conformities;
- Measurements taken by Kiwa in case of improper Use of Certificates, Certification Marks, Pictograms and Logos;
- Terms for termination of the certificate;
- The possibility to lodge an appeal against decisions of measurements taken by Kiwa.

## 8.2 Certification staff

The staff involved in the certification may be sub-divided into:

- certification experts: they are in charge of carrying out the pre-certification tests and assessing the inspectors' reports;
- inspectors: they are in charge of carrying out external inspections at the supplier's works;
- decision-makers: they are in charge of taking decisions in connection with the pre-certification tests carried out, continuing the certification in connection with the inspections carried out and taking decisions on the need to take corrective actions.

### 8.2.1 *Qualification requirements*

Distinguished are:

- Qualification requirements for executive staff of a CI that fulfil the requirements of EN 45011;
- Qualification requirements for executive staff of a CI that are in addition set up by the Board of Experts for the subject of this evaluation guideline.

The level of education and the experience of the certification staff involved should be demonstrably recorded.

	Certification engineer	Inspector	Decision-maker
Education - general	<ul style="list-style-type: none"> <li>• Relevant tech. thinking and working level comparing to Bachelor</li> <li>• Internal training in certification and Kiwa policies</li> <li>• Training in audit skills</li> </ul>	<ul style="list-style-type: none"> <li>• Tech. thinking and working level at vocational education (intermediate level)</li> <li>• Internal training in certification and Kiwa policies</li> <li>• Training in audit skills</li> </ul>	<ul style="list-style-type: none"> <li>• Thinking and working at Bachelor level</li> <li>• Internal training in certification and Kiwa policies</li> <li>• Training in audit skills</li> </ul>
Education - specific	<ul style="list-style-type: none"> <li>• For BRL relevant technical education</li> <li>• Specific courses and training (knowledge and skills)</li> </ul>	<ul style="list-style-type: none"> <li>• For BRL relevant technical education</li> <li>• Specific courses and training (knowledge and skills)</li> </ul>	<ul style="list-style-type: none"> <li>• not applicable</li> </ul>
Experience - general	<ul style="list-style-type: none"> <li>• 1 year of relevant work experience with at least 4 pre-certification tests of which 1 complete pre-certification test carried out independent under supervision</li> </ul>	<ul style="list-style-type: none"> <li>• 1 year of relevant work experience with a minimum of 4 pre-certification tests of which 1 carried out independent under supervision</li> </ul>	<ul style="list-style-type: none"> <li>• 4 years of working experience, with at least 1 year in certification</li> </ul>
Experience - specific	<ul style="list-style-type: none"> <li>• Detailed knowledge of the BRL and 4 certification tests carried out on the basis of the BRL or one related</li> </ul>	<ul style="list-style-type: none"> <li>• Detailed knowledge of the BRL and 4 certification tests carried out on the basis of the BRL or one related</li> </ul>	<ul style="list-style-type: none"> <li>• General knowledge of the BRL</li> </ul>

### 8.2.2 *Qualification*

Certification staff must be demonstrably qualified by evaluation of education and experience of the above-mentioned requirements. In case qualification takes place on the basis of other criteria, then this has to be recorded in writing.

The authority for qualification rests with:

- Decision-makers: qualification of the certification experts and inspectors;
- Management of the certification body: qualification of the decision-makers.

### 8.3 **Report pre-certification tests**

Kiwa records the results of the pre certification tests in a report. This report shall comply with the following requirements:

- completeness: the reports verdicts about all requirements included in the evaluation guideline;
- traceability: the findings on which the verdicts have been based shall be recorded traceable;
- basis for decision: the decision maker shall be able to base his decision on the findings included in the report.

### 8.4 **Decision for granting of the certificate**

The decision for granting the certificate shall be made by a qualified decision maker which has not been involved in the pre certification tests. The decision shall be recorded traceable.

### 8.5 **Lay-out of the quality declaration**

The product certificate shall be in accordance with the model as included in annex II and III.

## 8.6 Nature and frequency of external inspections

The certification body shall carry out Audits at the supplier at regular intervals to check whether the supplier complies with his obligations. About the frequency of inspections the Board of Experts decides.

At the time this Evaluation Guideline took effect, the frequency was set at number of 4 inspection visits per year. In case the supplier is certified on the basis of ISO 9001 for the applicable scope, the frequency is set at a number of 2 inspection visits per year.

Inspections shall at least refer to:

- The suppliers IQC-scheme and the results obtained from inspections carried out by the supplier;
- The correct way of marking of certified products;
- Complying with required procedures.

The results of each inspection shall be traceable recorded in a report.

## 8.7 Interpretation of requirements

The Board of Experts may record the interpretation of requirements of these evaluation guidelines in one separate interpretation document.

# 9 List of mentioned documents

## 9.1 Rules by public law

Gazette of 13 December 2002, nr. 241, page 25      Regeling materialen en chemicaliën leidingwatervoorziening  
(*Regulation materials and chemicals drinking water supply*)

## 9.2 Standards / normative documents

ISO 7-1	Pipe threads where pressure-tight joints are made on the threads – Part 1: Dimensions, tolerances and designation
ISO 161-1	Thermoplastics pipes for the conveyance of fluids – Nominal outside diameters and nominal pressures — Part 1: Metric series
ISO 228-1	Pipe threads where pressure-tight joints are not made on the threads – Part 1: Dimensions, tolerances and designation
EN-ISO 580	Plastic piping and ducting systems - Injection-moulded thermoplastic fittings - Methods for visually assessing the effects of heating
EN 579	Thermoplastics plastics piping systems - PE-X pipes - Determination of the degree of crosslinking by solvent extraction
NEN-EN 681	Elastomeric seals - Materials requirements for pipe joint seals used in water and drainage applications - Part 1: Vulcanized rubber
EN 712	Thermoplastics plastics piping systems – End-load bearing mechanical joints between pressure pipes and fittings – Test method for resistance to pull-out under constant longitudinal force
EN 713	Plastics piping systems – Mechanical joints between fittings and polyolefin pressure pipes – Test method for leak tightness under internal pressure of assemblies subjected to bending
EN-ISO 1133	Determination of the melt mass flow rate (MFR) and the melt volume (MVR) of thermoplastics
EN-ISO 1167-serie	Plastics piping systems - Thermoplastics pipes - Determination of the resistance to internal pressure at constant temperature, 1995.
NEN-EN 1254-3	Copper and copper alloys – plumbing fittings – Part 3: Fittings with compression ends for use with plastic pipes
ISO 2505	Plastics piping and ducting systems – Thermoplastic pipes. Determination of the longitudinal reversion
ISO 2578	Plastics – Determination of time-temperature limits after prolonged exposure to heat
ISO 3126	Plastics piping systems – Plastics components – Determination of dimensions
ISO 4065	Thermoplastic pipes - Universal wall thickness table

DIN 4724	Kunststoff-Rohrleitungssysteme für Warmwasser-Fußbodenheizung und Heizkörperanbindung Vernetztes Polyethylen mittlerer Dichte (PE-MDX)
NEN-EN-ISO 6708	Pipework components. Definition and selection of DN (nominal size)
EN-ISO 6957	Copper alloys – Ammonia test for stress corrosion in resistance
ISO 9080	Plastics piping and ducting systems – Determination of long-term hydrostatic strength of thermoplastics material in pipe form by extrapolation
ISO 10508	Plastics piping systems for hot and cold water installations – Guidance for classification and design.
ISO 11357-1	Plastics – Differential Scanning Calorimetry (DSC) – Part 1: general principles
ISO 11357-3	Plastics – Differential Scanning Calorimetry (DSC) – Part 3: Determination of temperature and enthalpy of melting and crystallization
EN 12293	Plastics piping systems – Thermoplastics pipes and fittings for hot and cold water – Test method for the resistance of mounted assemblies to temperature cycling
EN 12294	Plastics piping systems for hot and cold water – Method of test for leak tightness under vacuum
EN 12295	Plastics piping systems – Thermoplastics pipes and fittings for hot and cold water – Test method for resistance of joints to pressure cycling
ISO 13760	Plastics pipes for the conveyance of fluids under pressure – Miner's rule – Calculation method for cumulative damage
EN ISO 15875 part 1-5	Plastic piping systems for hot and cold water installations- Cross-linked Polyethylene (PE-X)
DIN 16894	Rohre aus vernetztem Polyethylen mittlerer Dichte (PE-MDX) - Allgemeine Qualitätsanforderungen, Prüfung
ISO 17455	Plastics piping systems – Multilayer pipes – Determination of the oxygen permeability of the barrier pipe
ISO 17456	Plastics piping systems – multilayer pipes – Determination of the long-term strength
ISO 21003 series	Multilayer piping systems for hot and cold water installations – inside buildings

# I Thermal durability outer layer

## I.1. Principle of the method

A pipe sample of the PE-X/Al pipe is placed in an oven for a defined time at an elevated temperature. After aging in the oven, the test piece is bended to produce a required axial strain in the outside layer. The layer is observed visually for cracks

## I.2. Apparatus

— Oven

— Bending template:

1. pipe
  2. stop block
  3. air release valve
  4. end fitting
  5. stop nipple
  6. bending gauge
  7. test panel
  8. valve
  9. connection to hydraulic pressure generator
  10. pressure gauge
  11. connection nipple
  12. test fitting
- $l_1$  total length of the pipe  
 $l_2$  bending length of the pipe  
 $r$  bending radius

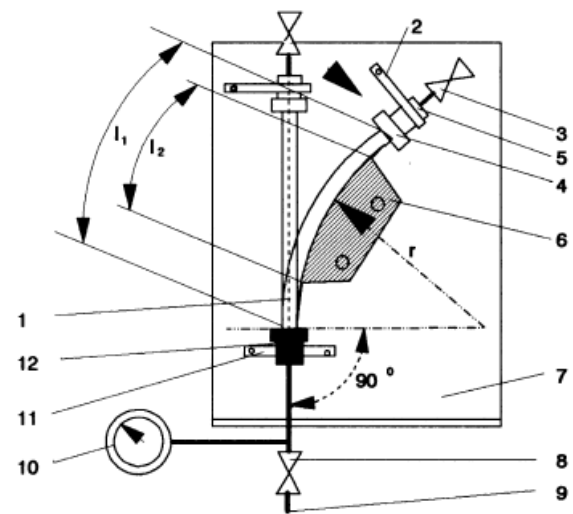

Figure 1 – Bending template

## I.3. Procedure

### 1. Oven aging:

Polyolefin 110°C/1 year

### 2. Deformation:

Bending with bending template similar to EN 713 at room temperature ( $23 \pm 1$ )°C after at least 24 hours.

Bending parameters see table I.1

Speed of the deformation: min. 3 s, max. 10 s (for the complete deformation)

Table I.1 – Bending parameters

Pipe material	total pipe length $l_1$	bending length $l_2$	bending radius $r$
polyolefin	10 D	7,5 D	16 D
D: outside diameter of the pipe			

A strain of 3 % is required for polyolefin pipes..

#### **Example**

For a pipe with 32 mm outside diameter the required bending template radius is calculated as follows:

$$R = 16 \times D = 16 \times 32 \text{ mm} = 512 \text{ mm}$$

Strain of the outer fibre in relation to the neutral fibre of the pipe:

$$\varepsilon = \left\{ \frac{r + D}{r + D/2} \right\} - 1 = \left\{ \frac{17 \times D}{16,5 \times D} \right\} - 1 = 0,0303 \text{ ( 3,0 \% )}$$

#### **I.4. Requirements**

No visual cracks in the outer layer.

## II Model Technical approval-with-product certificate

Technical approval-with-product certificate  
KXXXXXXXX/OX



Issued

Replaces

Page 1 of 2

**Name product**

**Name supplier**

### STATEMENT BY KIWA

This technical-approval-with-product certificate is issued by Kiwa on the basis of BRL K123 "title", in accordance with the Kiwa Regulations for Product Certification.

Kiwa declares that legitimate confidence exists that the by the producer manufactured plastics piping system comply with the technical specifications as laid down in this technical approval-with-product certificate, provided that the plastics piping system have been marked with the Kiwa®-mark in the manner as indicated in this technical approval-with-product certificate.

Within the framework of this technical approval-with-product certificate Kiwa does not impose any inspections with regard to the production of other parts of the plastics piping system nor the manufacturing of the plastics piping system itself.

Bouke Meekma

Publication of the certificate is allowed

Advice: consult [www.kiwa.nl](http://www.kiwa.nl) in order to ensure that this certificate is still valid

Kiwa Nederland B.V.  
Sir W. Churchill-laan 273  
Postbus 70  
2280 AB RIJSWIJK  
The Netherlands  
Tel. ++31 (0)70 414 44 00  
Fax ++31 (0)70 414 44 20  
[www.kiwa.nl](http://www.kiwa.nl)



### Certificate holder/Supplier

Tel.

Fax

[www.kiwa.nl](http://www.kiwa.nl)

E-mail

Certification process consists of initial and regular evaluation of:

- quality system
- product



**Name product**

---

**PRODUCT SPECIFICATION**

The products mentioned below belong to this technical approval-with-product certificate.

**Fill-out**

**Toxicological requirements**

The pipes and fittings used in this system are approved on the basis of the requirements set in the "Regeling materialen en chemicaliën leidingwatervoorziening" ("Regulation materials and chemicals for drinking water supply"; published in the Government Gazette). The ATA-criteria are recorded in the respective product certificates.

**MARKING**

The products are marked with the KIWA<sup>®</sup>-mark.  
The realization of the marks as follows:

The mark and the production date are placed on the product and/or packaging and/or delivery documents.

**Application and use**

**Fill-out**

**RECOMMENDATIONS FOR USERS**

Check at the time of delivery whether:

- the producer has delivered in accordance with the agreement;
- the mark and the marking method are correct;
- the products show no visible defects as a result of transport etc..

If you should reject a production on the basis of the above, please contact:

- **Company**

And, if necessary:

- Kiwa Nederland B.V..

Consult the producer's processing guidelines for the proper storage, transport and processing methods.

### III Model Product certificate

**Product certificate**  
**KXXXXXXXX/OX**

Issued  
Replaces  
Page 1 of 2

**kiwa**   
Partner for progress

**Name product**  
**Name supplier**

**STATEMENT BY KIWA**  
This product certificate is issued by Kiwa on the basis of BRL K123 "title", in accordance with the Kiwa Regulations for Product Certification.

Kiwa declares that legitimate confidence exists that the by the producer manufactured plastics piping system comply with the technical specifications as laid down in this product certificate, provided that the plastics piping system have been marked with the Kiwa®-mark in the manner as indicated in this product certificate.

  
Bouke Meekma

Publication of the certificate is **not** allowed.

**Advice: consult [www.kiwa.nl](http://www.kiwa.nl) in order to ensure that this certificate is still valid**

**Certificate holder/Supplier**  
Tel.  
Fax **www**  
E-mail

**Certification process consists of initial and regular evaluation of:**

- quality system
- product

**Certificaat**

Kiwa Nederland B.V.  
Sir W. Churchill-Haan 273  
Postbus 70  
2280 AB RIJSWIJK  
The Netherlands  
Tel. ++31 (0)70 414 44 00  
Fax ++31 (0)70 414 44 20  
[www.kiwa.nl](http://www.kiwa.nl)

  
PRODUCTS  
RVA C 002

## Name product

### PRODUCT SPECIFICATION

#### Product specification

The products mentioned below belong to this product certificate.

Fill-out

#### Toxicological requirements

Application:

The pipes and fittings used in this system are approved on the basis of the requirements set in the "Regeling materialen en chemicaliën leidingwatervoorziening" ("Regulation materials and chemicals for drinking water supply"; published in the Government Gazette).

ATA criteria:

The ATA product certification is based on two main criteria. It should permanently comply with:

- The product recipe approved during the assessment procedure. The recipe is laid down in the for confidentiality reasons undisclosed appendix 1A to the certification agreement K12345. This recipe is not to be changed without prior approval by Kiwa according to the Kiwa-ATA-approval procedure;
- Specific ATA-product requirements, laid down in appendix 1A to the certification agreement K12345. For confidentiality reasons this appendix 1A is not public.

Field of application **(ONLY APPLICABLE FOR RUBBER SEALING RINGS)**

The rubber sealing rings are applied in cold water applications ( $\leq 25$  °C) / warm water applications ( $\leq 60$  °C) / hot water applications ( $> 60$  °C). **(MAKE A CHOICE)**

#### Marking

The products are marked with the KIWA<sup>®</sup>-mark.

The products are provided with at least the following marking:

Fill-out

The realization of the marks is as follows: clearly and indelible on place

#### Application and use

Fill-out

### RECOMMENDATIONS FOR USERS

Check at the time of delivery whether:

- the producer has delivered in accordance with the agreement;
- the mark and the marking method are correct;
- the products show no visible defects as a result of transport etc..

If you should reject a production on the basis of the above, please contact:

- Company

And, if necessary:

- Kiwa Nederland B.V..

Consult the producer's processing guidelines for the proper storage, transport and processing methods.

## IV Model IQC-scheme

Subjects	Aspects	Method	Frequency	Registration
Raw materials or materials supplied: <ul style="list-style-type: none"> <li>• Recipe sheets</li> <li>• Incoming inspection raw materials</li> </ul>				
Production process, production equipment, material; <ul style="list-style-type: none"> <li>• Procedures</li> <li>• Work instructions</li> <li>• Equipment</li> <li>• Material</li> </ul>				
End products				
Measuring and testing equipment <ul style="list-style-type: none"> <li>• Measuring equipment</li> <li>• Calibration</li> </ul>				
Logistics <ul style="list-style-type: none"> <li>• Internal transport</li> <li>• Storage</li> <li>• Packaging</li> <li>• Preservation</li> <li>• Identification or marking of semi-finished and finished products</li> </ul>				